











Installation manual for fire-resistant steel hatch FQ EI30 and EI60



Attention! General warnings!

A Series of precautions must be taken to install this hatch. For safety reasons pay attention to following warnings and instructions! In case of doubt contact the supplier. This manual is meant for experienced installer.

-  This manual includes only the installation of hatch. Additional elements require separate instructions.
-  Read this manual carefully before installation.
-  Certain parts of this product may have sharp edges. Protective gloves are recommended.
-  Parts of the hatch are heavy.
-  All that is necessary to install this hatch is included in the package except insulation material between the wall and the frame and support blocks. Adding other elements may affect safety and warranty.
-  Make sure that there is enough light in the installation area. Remove items not necessary and dirt. Unauthorized persons (especially children!) may get hurt if present.
-  Make sure that the wall is strong enough for installation. In case of doubt contact the constructor.
-  If the installation is not in accordance with the instructions and if locks and materials not specified by the manufacturer are used for the door set, the door will lose its performance properties. In this case, the door does not meet its certification and declared properties, and the marking referring to the certificate must be removed from the door by the responsible of the works.

In case of questions contact AS Saku Metall Uksetehas.



1 TOOLS AND FIXINGS

Fire-resistant steel hatch FQ can be installed in vertical openings of concrete, stone or lightweight concrete walls. Minimum density of lightweight concrete is 650 kg/m³.

Frame is installed using screws and dowels or with adjustable sleeves and screws.

When using screws and dowels use Ø8x100 screws and Ø10 mm dowels to install the frame. Dimension of hexagon head of fixing screw is 13 mm. For drilling in stone and concrete walls use stone drill with Ø10 mm diameter.

Support blocks used for levelling the frame must be made of non-combustible materials. Covering caps for fixings are with a diameter of Ø19 mm.

For frames with ESSVE sleeves (Figure 2) use the following fixings with Torx 30 head:

- Concrete walls: ESSVE art. 105267 (7,5x65), drill hole Ø6x100 mm
- Lightweight concrete walls: ESSVE art. 105232 (8,0x120), no drilling required

Use 10 mm hex key to adjust the sleeves.

2 DIFFERENT METHODS OF INSTALLATION

Figure 1.

Frame installation with Ø8x100 mm screws

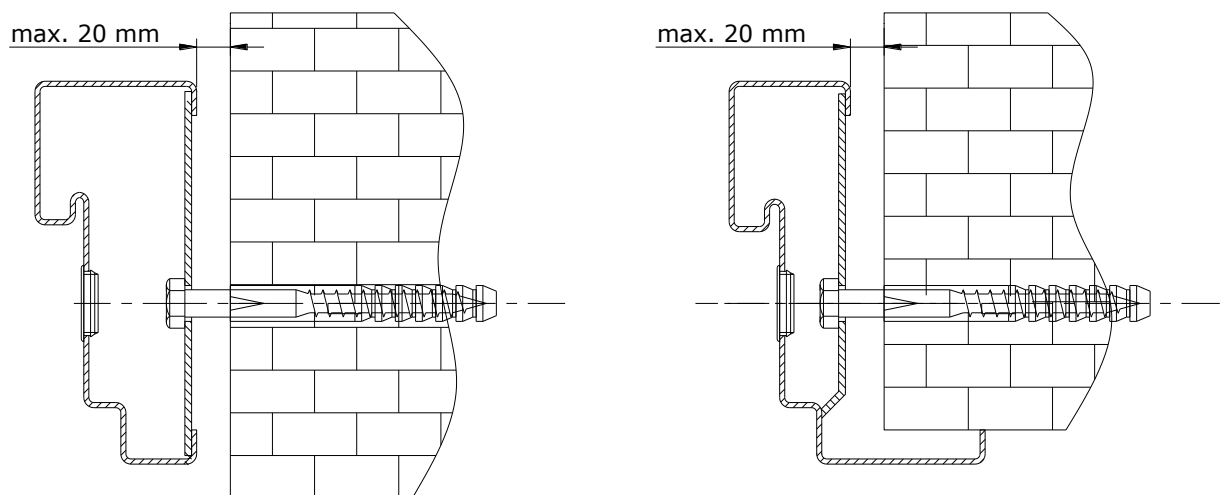
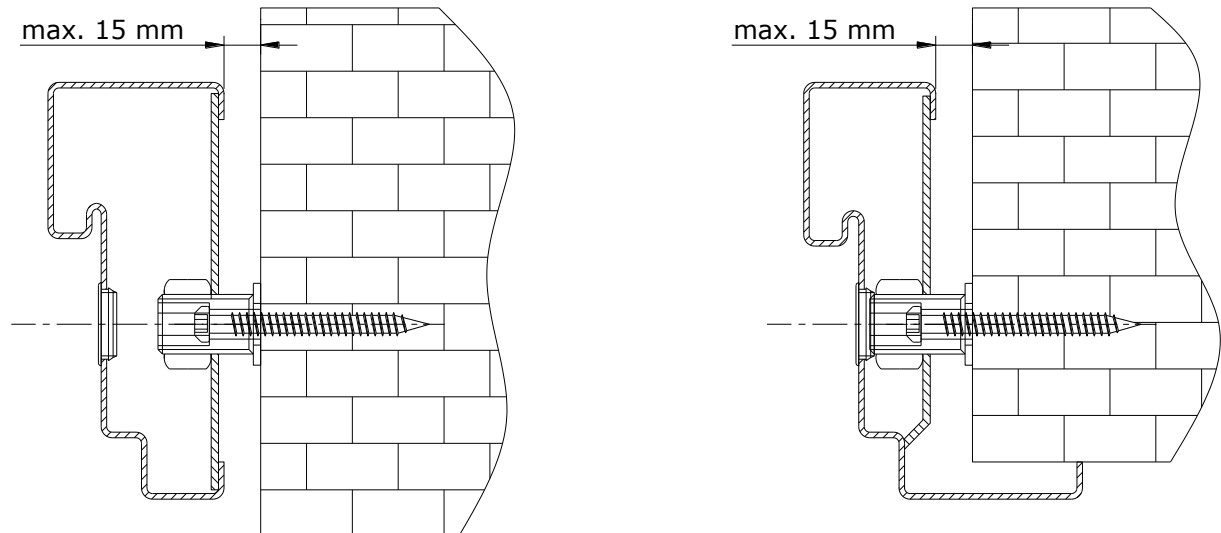



Figure 2.
Frame installation with sleeves



3 ORDER OF INSTALLATION

1. Upon placing the hatch on floor or ground use rubber, board, wood or plastic material for protection of paint layer.
2. Check the presence of fixings and tools.
3. Check the preparation of construction aperture. The greatest allowed width of construction aperture from frame is +40 mm and height +20 mm (for frames with sleeves +30 mm and +15 mm accordingly). In case of larger gaps make the construction aperture into compliance with the required dimensions. Ensure that frame and fixing devices do not contact possible public utility networks inside the wall.
4. Place the frame without hatch sheet in construction aperture, at specified distance from external surface of wall. Ensure that support points of the frame remain under side profiles, to prevent later sinking of hatch. Check levelling of upper profile of the frame. Use metal plates as bearing support blocks.
5. Level the hinge side of the frame and start fixing the frame from fixing apertures 1, 2 and 3 (Figure 3).
 - 5.1. On a frame without sleeves, when tightening the screws ensure that gaps between the frame and wall are equal. Place support blocks in the gap against screw, in order to support every fixing point of the frame and then tighten the screws finally. Check vertical position of side surfaces of the frame. If necessary, loosen the screw and correct position of the frame.
 - 5.2. On frames with sleeves, tighten the sleeves against the wall (Figure 2). Frames with sleeves do not require support blocks between the frame and the wall. If the sleeve does not extend to the wall, use additional fire-resistant plates. Use proper fixings for ESSVE sleeves (section 1 Tools and fixings). Tighten the screws.
6. Ensure that there is lubricant on hinges and support bearings. Lift the hatch sheet on hinges. Check parallelity of gaps between hatch sheet and frame and external hatch surface and the frame surface. If necessary adjust the screws and width of the support blocks. On frames



with sleeves loosen the screw and correct the gaps by adjusting the sleeves with a hex key. Tighten the screws.

7. Fix the frame in all of the other remaining fixing points, ensuring parallelity of gaps and support of fixing points with support blocks (or sleeves).
8. Check with induction tester that the product is not under live electric voltage. Otherwise switch off the power and perform grounding of the product. Electrical work may be performed only by qualified electrician.
9. Close fixing apertures of the frame with plastic caps.
10. Siliconize the gaps between the floor and threshold of external hatches. External and internal side must be sealed. Allowed silicones are Soudal Soudaflex 40FC, Soudal Silirub 2/S and Penosil General Silicone.

Figure 3
Fixing points of the frame

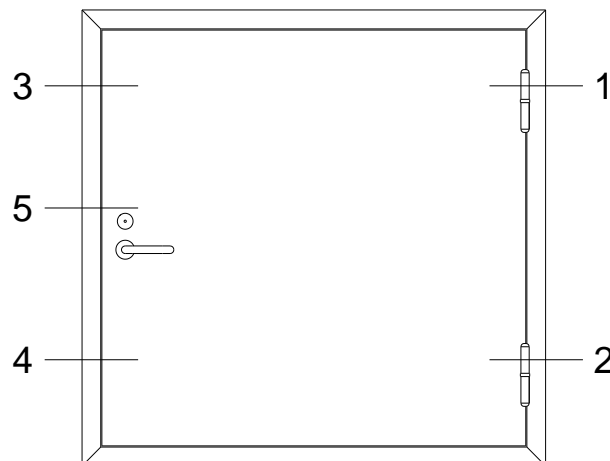

4 FILLING THE GAP BETWEEN THE FRAME AND THE WALL. FINISHING.

1. Fill the gaps between the frame and the wall with fire resistant foam Soudafoam FR or mineral wool with density $>70 \text{ kg/m}^3$.
2. After tightening of external gaps of the frame check free movement of hatch.
3. Filled gaps shall be finished with construction plate, plaster mixture or cover with metal slats fixed with rivets.

NB! Hatch package does not include infilling, metal slats or support block materials!

5 HARDWARE INSTALLATION

Install locks according to installation manuals of locks. It is forbidden to remove the blocks of mineral wool located at the sides of the lock openings! Use self-drilling screws for fastening the lock. Fix handles to the lock and check closure and operation of lock tumbler (and latch bolt) with opening and closing of hatch. Check opening of lock with keys.